

翘板开关 (ROCKER SWITCH)

Specification:

Rating: 10(10)A 250VAC T85/55
 16A 125VAC, 8A 250VAC
 Function: on-off-on
 Operating Force: 6N
 Connections: 2.8X0.8, Soldering
 Approvals: CQC, UL, cUL, TUV

KAN-D1

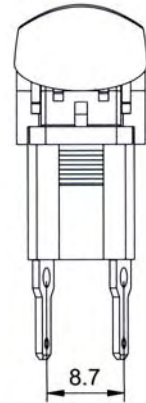
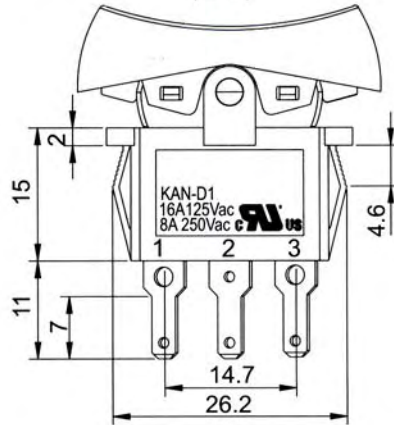
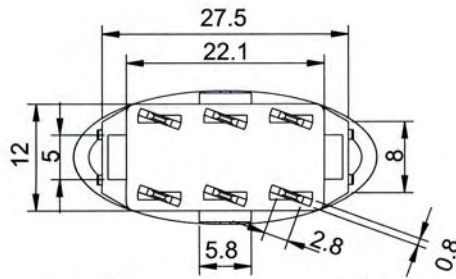
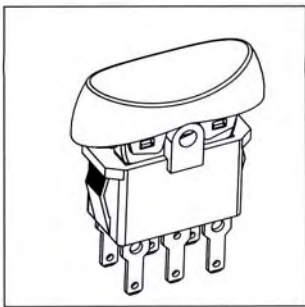

CIRCUIT DIAGRAM:

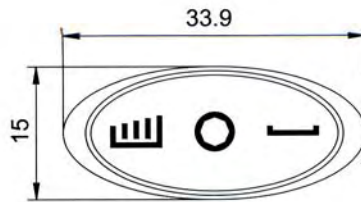
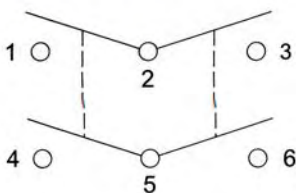

PANEL CUT OUT:

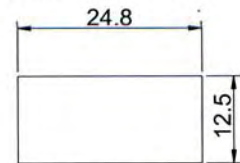

PLASTIC THICKNESS: 0.7-3.5

